

XTOOL | P2

Instructions

XTOOL



THANK YOU!

Dear xTooler:

Thank you for choosing xTool P2. We are so grateful for your recognition, and sincerely hope you will enjoy this product!

xTool P2 is an intelligent desktop 55 W CO₂ laser cutter. With two cameras providing a high positioning accuracy, it allows you to get started easily. In addition to the common cutting and engraving functions, it supports engraving of curved surfaces, automatic material feeding, and rotary engraving, significantly broadening your creation boundaries.

Our mission is to make it easier for everyone to create with our machine. We attach great importance to product experience and user suggestions. Please let us know if you have any questions anytime. We are always here to help.

By visiting our online store, you can also find our latest accessories and various materials to maximize the magic of xTool P2.

Thanks again for your support, and we will consistently provide quality products and services in the future.

Sincerely,

 CEO

Official Website: xtool.com

Support center: support.xtool.com

Technical support: support@xtool.com

Statement

- Thank you for choosing the xTool products!
- If you use the product for the first time, read carefully all the accompanying materials of the product to improve your experience with it. If you do not use the product according to the instructions and requirements of the Manual, or mis-operate the product due to misunderstanding, etc., the Company shall bear no responsibility for any loss resulting therefrom.
- The Company has collated the content of the Manual rigorously and carefully, but errors or omissions may remain.
- The Company is committed to continuously improving product functions and service quality, and therefore reserves the right to change any product or software described in the Manual and the content of the Manual at any time.
- The Manual is intended to help you use the product properly and does not include any description of hardware and software configuration. For product configuration, refer to the related contract (if any) and packing list, or consult your distributor. Images in the Manual are for reference only and the actual product may vary.
- Protected by copyright laws and regulations, the Manual shall not be reproduced or transcribed in any way, or be transmitted on any wired or wireless network in any manner, or be translated into any language, or be modified in any way, such as content, image, or layout modification, without the prior written authorization of the Company.

Statement	1
Safety First (Important)	2
List of items	6
Meet your xTool P2	7
Use xTool P2	9
Understand the indicator and screen	10
Use the material clamps	12
Use Rotary Attachment	13
Declaration of conformity	14
FCC statement	14
After-sales services	14

For online help, visit support.xtool.com.
To start using the machine, see the *Quick Start Guide*.

Safety First (Important)

DANGER—VISIBLE LASER RADIATION

AVOID EYE OR SKIN EXPOSURE TO DIRECT OR SCATTERED RADIATION.

1. General safety

Read and get familiar with all safety precautions and measures before using the machine. Strictly follow all safety precautions. Ensure that the machine is properly assembled and is working properly.

Follow the operating principles:

- Check the machine for damage every time before you use it. Do not operate it in any way when any damage or defect is found.
- Ensure that the workspace is clean and flat. Note that the laser tube is made of glass and is very fragile. If it is broken, the device will fail to work.
- Do not disassemble the machine or change its structure in any way without authorization. Do not modify or decompile its operating system.
- Do not leave the device unattended during operation.
- Keep the inside of the machine clean. Residues and chippings accumulated during cutting and engraving are dangerous and may cause fire. Clean the chippings and residues in the tray regularly.
- The machine works properly at the temperature of 10°C to 30°C and can be stored properly at the temperature of 10°C to 45°C. Do not operate it at a temperature lower than 0°C.

2. Laser safety

Under normal circumstances, the CO2 laser tube is completely enclosed in a casing during operation. The device has a safety interlock switch. If the lid is lifted during operation, the device will stop working to prevent harming people. No special precautions are required to ensure laser safety.

Follow the safety precautions:

- Do not operate the machine when any part of it is removed. Removing any part may expose the laser system and cause damage to the machine. Remember that the CO2 laser beam is invisible.
- Do not engrave or cut any material that contains PVC or vinyl (processing plastics is not recommended). These materials (and other materials containing chlorine/chloride) can generate corrosive vapor that is extremely harmful to the human body and can cause damage to the device. Any damage caused by engraving or cutting any material containing PVC or vinyl is not covered by the Company's warranty.
- Do not engrave or cut any unknown materials. Vaporization or melting of many materials, which include but are not limited to PVC and polycarbonate, may release harmful smoke. Do not leave the machine unattended when it is working.
- Laser operation is prohibited when the lid is lifted. Make sure that the lid is closed during operation and do not tamper with the safety mechanism of the lid.
- Do not operate the device before properly connecting a smoke purifier. Most materials produce irritating smoke when being processed. These include, but are not limited to, paints, varnishes, composite boards, and plastics that can produce hazardous compounds during processing.

The reference standard for laser safety is American National Standard for Safe Use of Lasers (Z136.1-2000), which is provided by the American National Standards Institute (ANSI).

This reference is the basis for federal regulations and laser system manufacturers, as well as the laser safety guidelines of Occupational Safety and Health Administration (OSHA). It contains details on the proper installation and use of laser systems.

3. Fire safety

A high-density laser beam is used by the device to irradiate the material to be cut or engraved, so as to heat up the material surface and vaporize the material without burning. But most materials are inherently flammable and may be ignited to form an open flame that can burn down the device (even if it is made of flame-retardant materials) and its surroundings. Experience shows that vector cutting with a laser is most likely to produce an open flame. In particular, acrylic has proven to be extremely flammable in vector cutting.

 Read the following warnings and suggestions carefully:

- Do not stack materials (especially organic ones, such as paper) around the machine. They may cause the spread of flames and increase the risk of material ignition.
- Do not leave the machine unattended when it is working. If the machine works with setting errors and is left unattended for a long period of time, or if a mechanical or electrical fault occurs, a fire may be caused.
- Clean the device regularly. Excessive accumulation of residues and chippings from cutting and engraving would increase the risk of fire. The tray needs be removed and cleaned periodically to ensure that there is no residue or chipping in the device.
- Ensure that the area around the machine is clean without any cluttered flammable materials, explosives, or volatile solvents, such as acetone, alcohol, or gasoline.
- Keep a fire extinguisher and perform regular maintenance and inspection of it.



Do not leave the device unattended when it is working.



Keep combustible materials away from the device.

4. Electrical safety

Laser tube of the device has a silicone rubber casing, which can effectively shield the internal power cord. If you find the cover is loose and the power cord is exposed, stop operating and contact customer service personnel.



Read the following warnings and suggestions carefully:

- Do not open any access panel on the device when the device is connected to the power supply. Accidental contact with the power supply may cause injury.
- Do not touch any electronic area with your hands or other tools when the machine is connected to a power supply.
- The power switch is on the back of the device. Press (-) to power it on and pressing (o) to power it off.

5. Warnings and instruction signs

On xTool P2, the warning and instruction signs are labelled where physical injuries or damage to the machine may be caused before and/or during operation. If a sign is damaged or lost, replace it immediately. You can use the following template to print the sign you need.

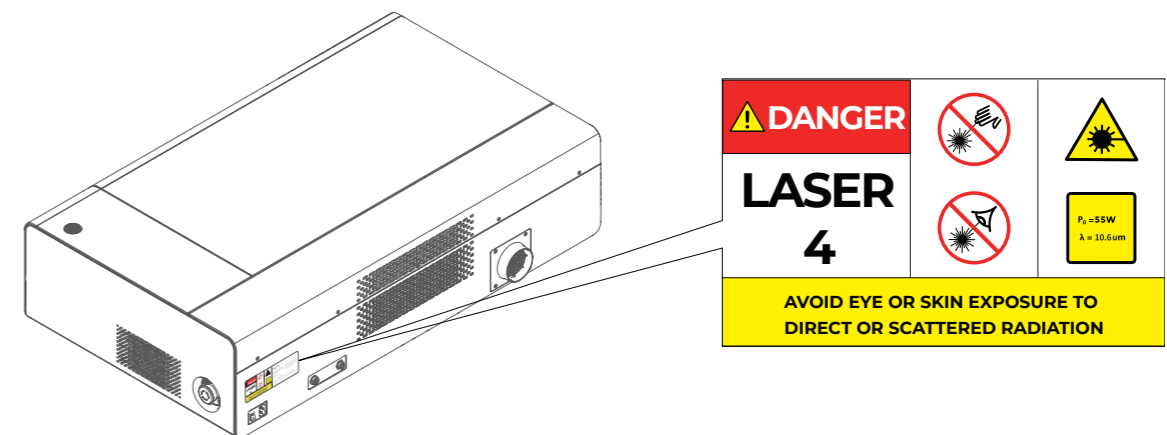

List of items



xTool P2

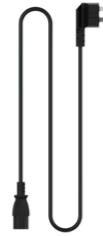

Power cable



USB cable (Type-C)



Smoke exhaust pipe components



Antifreeze



Funnel



Basswood 3 mm



Corrugated paper 3.5 mm



Transparent acrylic



Screwdriver



Hex key



Quick Start Guide



Instructions



Screw M3*6 (spare parts)



Screw M3*22 (spare part)

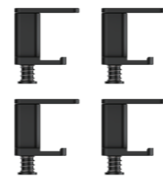

Material clamp

Meet your xTool P2

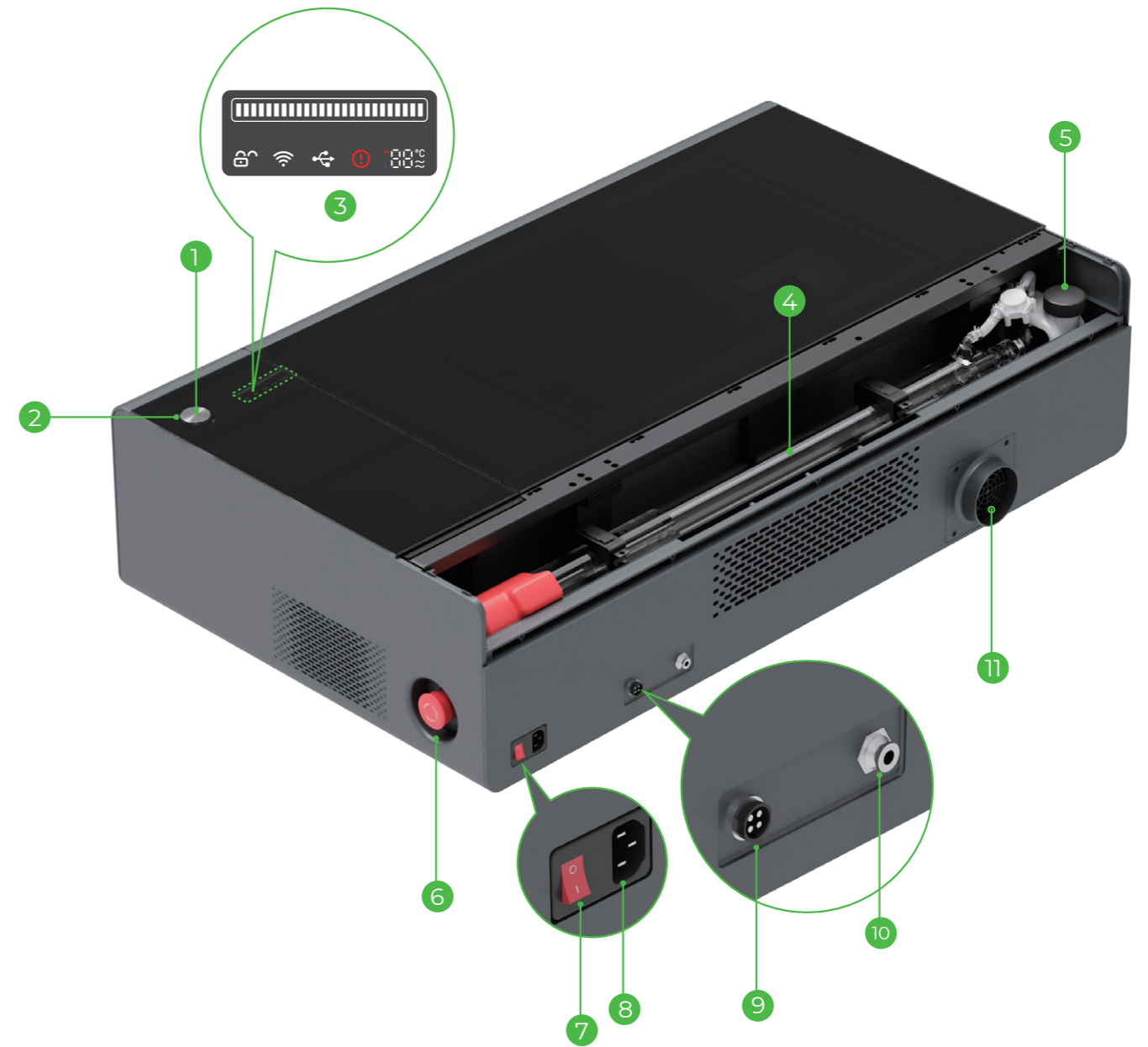

- 1 Button
- 2 Annular indicator
- 3 State display screen
- 4 Laser tube
- 5 Water tank
- 6 Emergency stop switch
- 7 Power switch
- 8 Power port
- 9 Fire safety set port
- 10 Tube fitting
- 11 Smoke outlet

Use xTool P2

1. Download and install xTool Creative Space (XCS)



xTool Creative Space



2. Connect xTool P2 to your computer and connect it to XCS

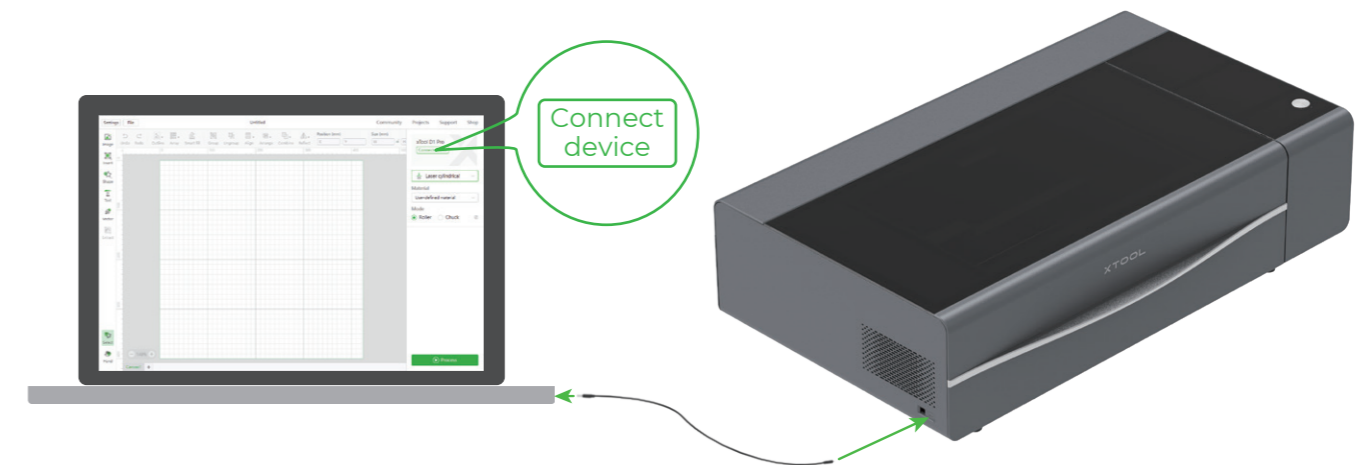

- 12 Distant-view camera
- 13 Close-view camera
- 14 Laser module
- 15 Extension port
- 16 Network port
- 17 USB port (Type-C)
- 18 Slat
- 19 Baseplate

You can start your creation after connecting them.
For details about how to use XCS to operate xTool P2, see support.xtool.com.

Understand the indicator and screen

Annular indicator	Screen	Device
Blinking in white	/	Starting
Solid white	Displays the temperature and lid locked/unlocked state	Standby, not connected
Solid white	Displays the icon of the connection mode	Standby, connected
Breathing green	/	Sleeping
Blinking blue and then solid blue	/	Ready to work
Solid blue	Progress bar blinks and moves	Performing a task
Solid blue	Progress bar stops moving	Task paused
Solid green	/	Task completed
Solid white	/	Task canceled
Solid purple	/	Firmware updating
Solid red	Fault indicator lit up	Exceptions occur
/	H or L lit up	Liquid temperature alarm H: Temperature too high L: Temperature too low
Breathing blue	/	Calibrating or image recognizing
Solid red	/	Calibration or recognition failed. You can open and then close the lid or use XCS to bring the device back to the standby state.
Solid yellow	/	Waiting for AP network setting. You can hold down the button on xTool P2 for 5 seconds to start AP network setting. If no network is set within 2 minutes, the device goes back the standby state. Name of the AP hotspot: XTOOL-P2-Last 6 digits of MAC address

Note: "/" indicates no state change.

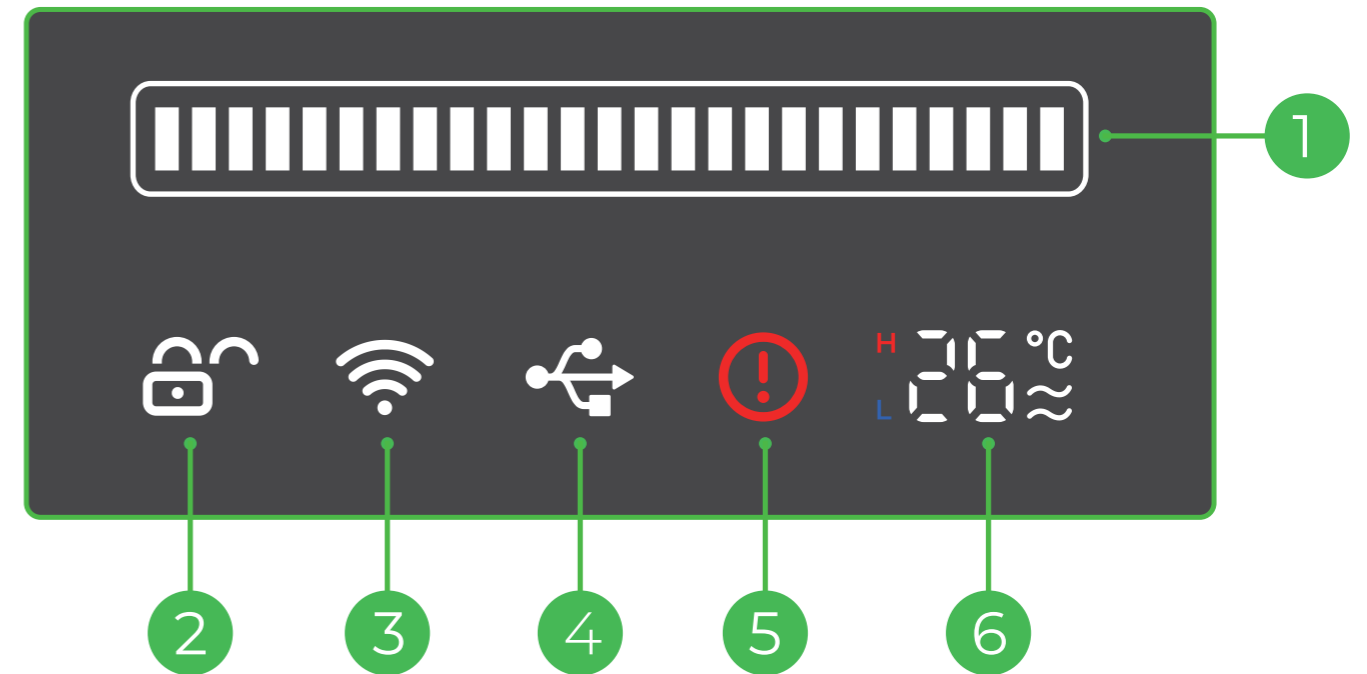

1. Progress bar

2. Lid locked / unlocked

Do not open the lid forcibly when it is locked. You can press the button on xTool P2 to unlock it before opening it.

3. Connected through Wi-Fi

4. Connected by using the USB cable

5. Exceptions occur

6. Liquid temperature

H: Temperature too high

L: Temperature too low

Use the material clamps

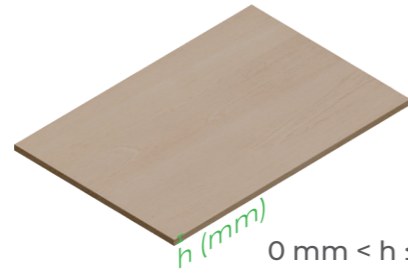
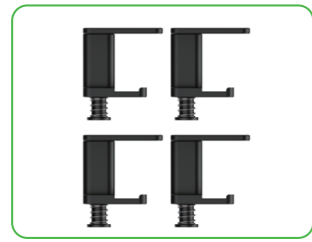

$0 \text{ mm} < h \leq 12 \text{ mm}$

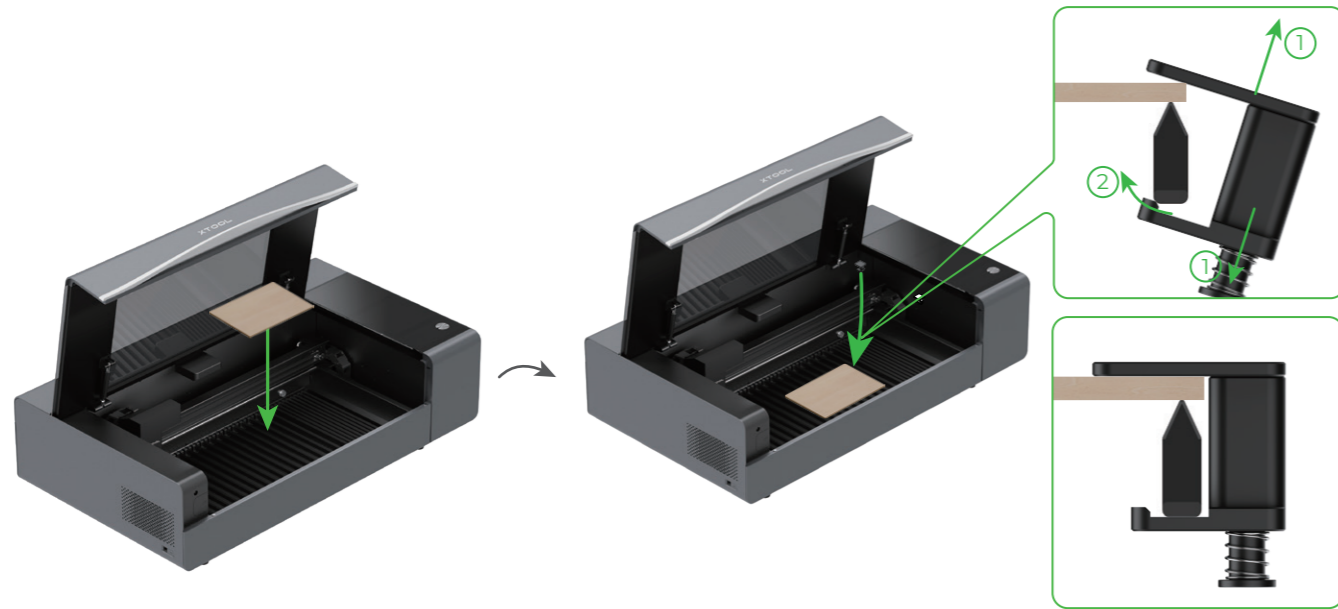

Fit the other three material clamps in the same way.

Use Rotary Attachment



No rotary attachment is included in the pack.

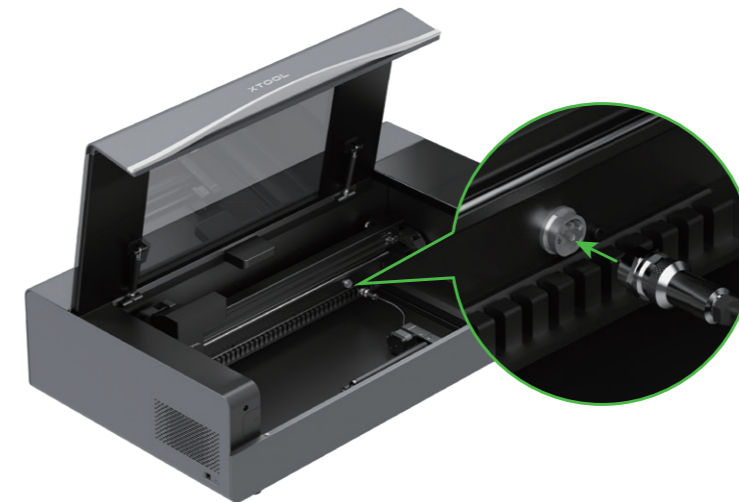
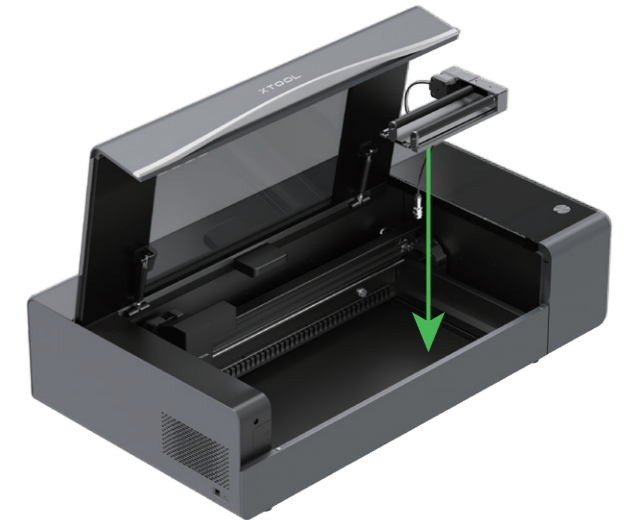
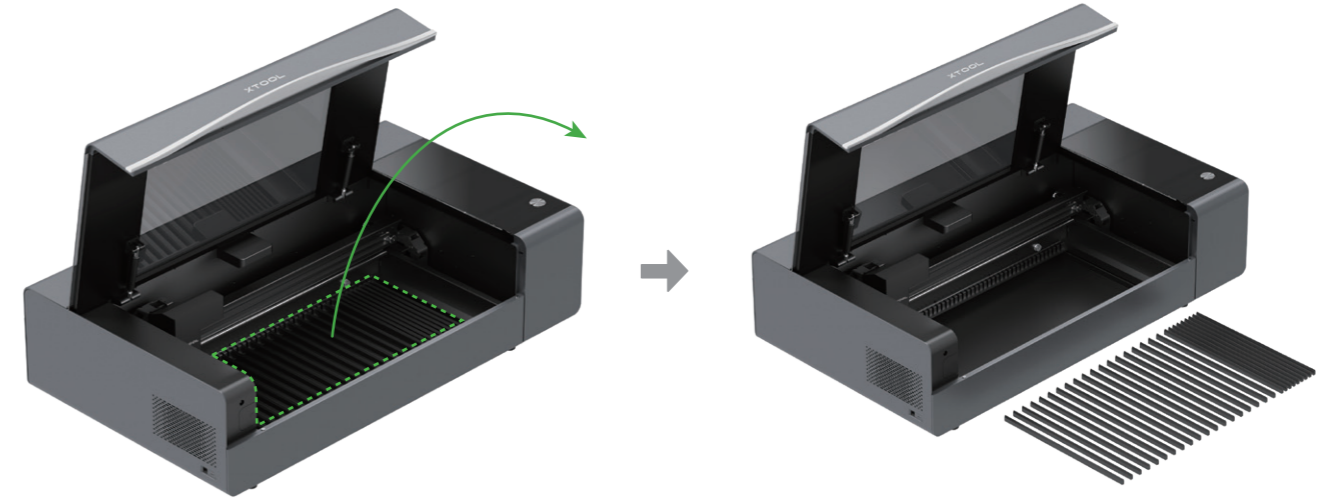

Declaration of conformity

Hereby, Makeblock Co., Ltd., declares that this product is in compliance with the essential requirements and other relevant provisions of Directive RED 2014/53/EU and the RoHS directive 2011/65/EU & (EU) 2015/863.

FCC statement

This device complies with Part 15 of the FCC Rules. Operation is subject to the following two conditions:

(1) This device may not cause harmful interference, and (2) This device must accept any interference received, including interference that may cause undesired operation.

Warning: Changes or modifications not expressly approved by the party responsible for compliance could void the user's authority to operate the equipment.

NOTE: This equipment has been tested and found to comply with the limits for a Class B digital device, pursuant to Part 15 of the FCC Rules. These limits are designed to provide reasonable protection against harmful interference in a residential installation. This equipment generates uses and can radiate radio frequency energy and, if not installed and used in accordance with the instructions, may cause harmful interference to radio communications. However, there is no guarantee that interference will not occur in a particular installation. If this equipment does cause harmful interference to radio or television reception, which can be determined by turning the equipment off and on, the user is encouraged to try to correct the interference by one or more of the following measures:

- Reorient or relocate the receiving antenna.
- Increase the separation between the equipment and receiver.
- Connect the equipment into an outlet on a circuit different from that to which the receiver is connected.
- Consult the dealer or an experienced radio/TV technician for help.

FCC radiation exposure statement

This equipment complies with FCC radiation exposure limits set forth for an uncontrolled environment. This equipment should be installed and operated with a minimum distance of 20 cm between the radiator and your body.

After-sales services

For technical support, contact us at support@xtool.com.

For more information about after-sales services, visit support.xtool.com.